

FESEL (F. Sequeira)

Equipamentos Industriais, Lda.

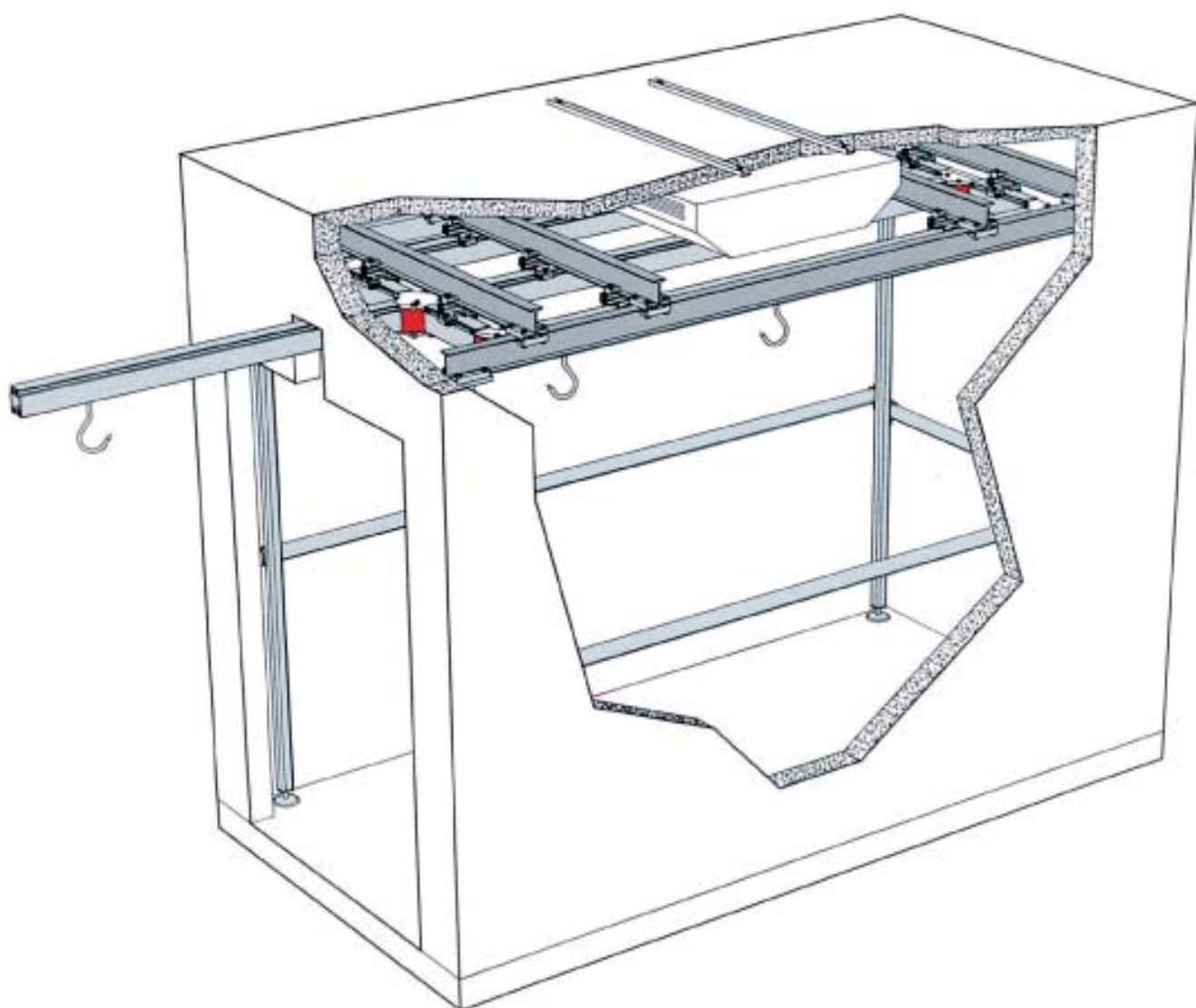

VIA AÉREA EM PERFIL DE ALUMÍNIO TIPO DESLIZANTE
COM SUSTENTAÇÃO POR MEIO DE VIGAS IPN E PILARES



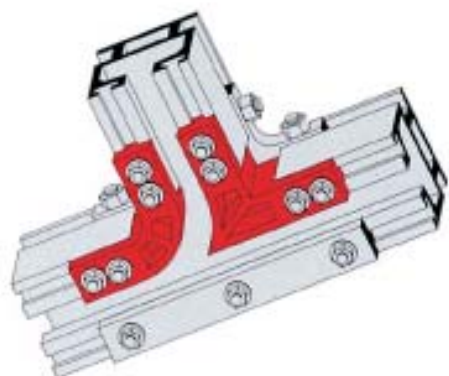

Artigo Nr. 528-E
Agulha Derivação Esquerda 90 Graus

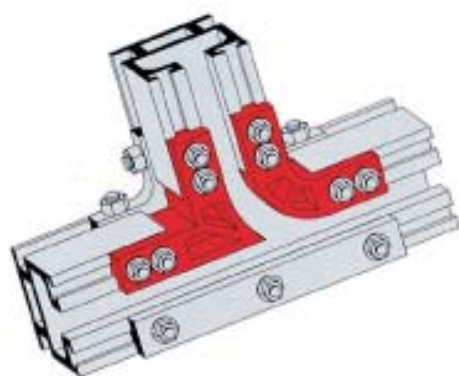

Artigo Nr. 528-D
Agulha Derivação Direita 90 Graus

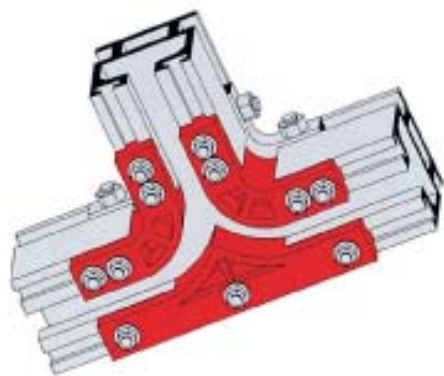

Artigo Nr. 528-C
Agulha Derivação Central

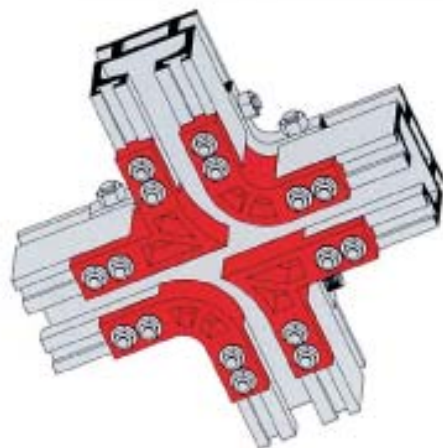

Artigo Nr. 528-Q
Agulha Derivação Quatro Vias

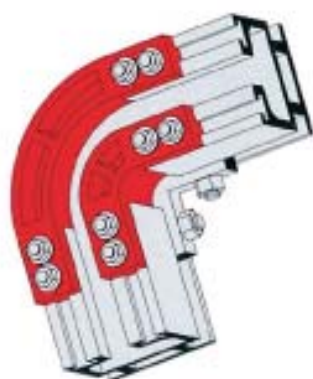

Artigo Nr. 530/90
Curva a 90 Graus

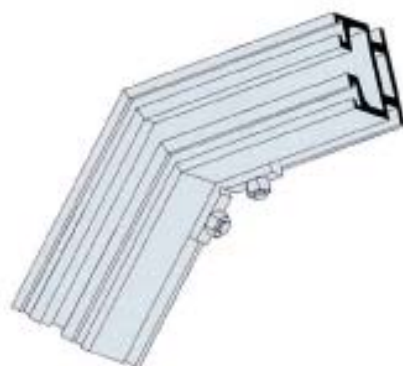

Artigo Nr. 530/135
Curva a 135 Graus

VIA DESLIZANTE Nr. 1992 - Exemplos de combinações possíveis entre as vias/ Símbolos das Agulhas e Curvas Medidas ao eixo

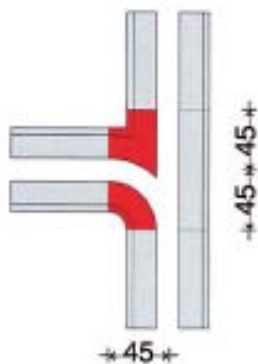
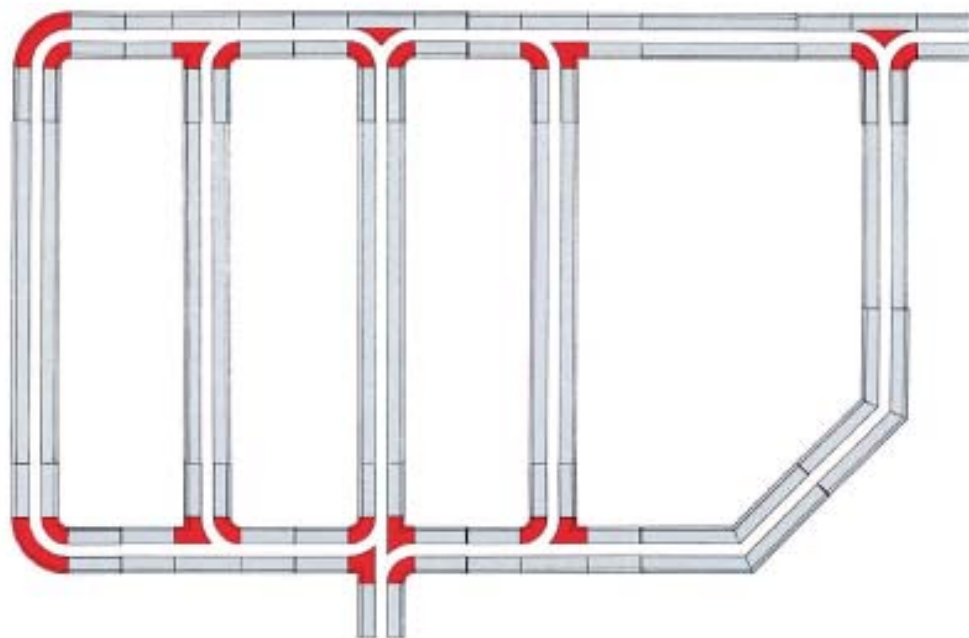

Agulha 90 Graus Esquerda

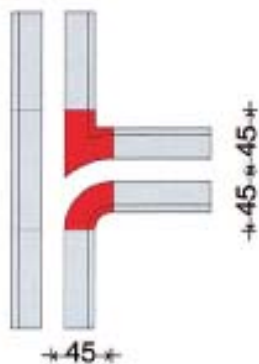

Agulha 90 Graus Direita

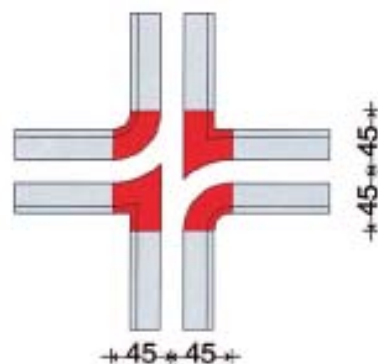

Agulha de Quatro Vias

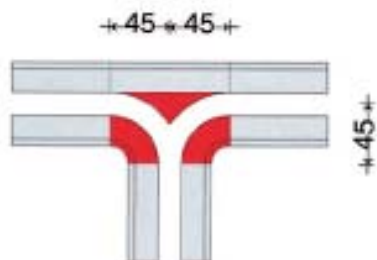

Agulha Central

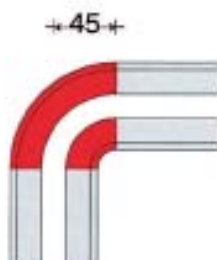

Curva a 90 Graus

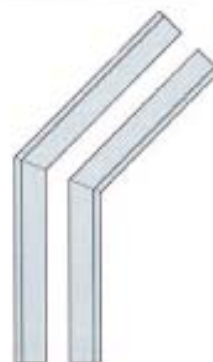

Curva a 135 Graus

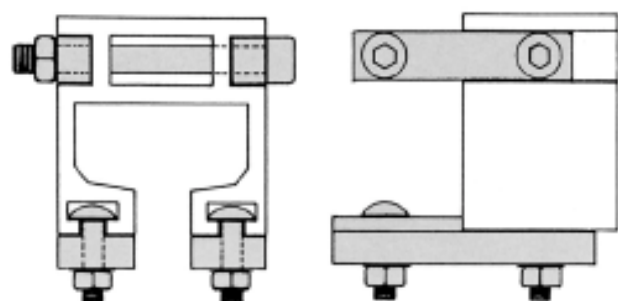
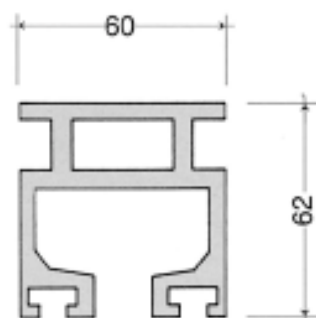

Artigo Nr. 421
União de Perfil

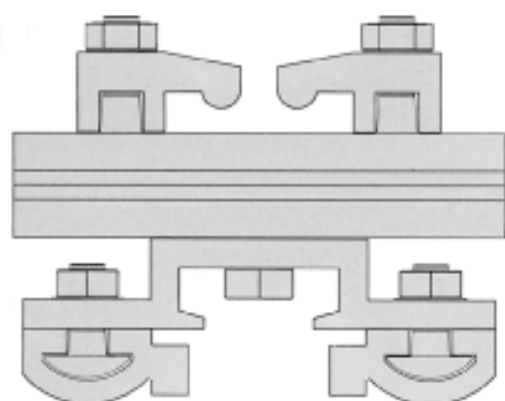

Artigo Nr. 414/416/407
Suporte de Alumínio com Peça Intercalar
e Peças de Aperto à Viga IPN

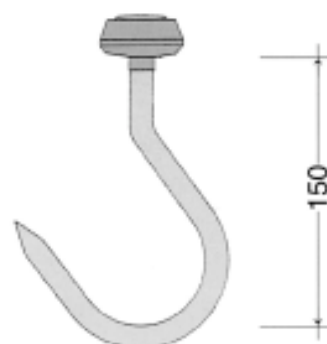

Artigo Nr. 462
Gancho Simples com Rótula



Artigo Nr. 461
Gancho Simples Articulado

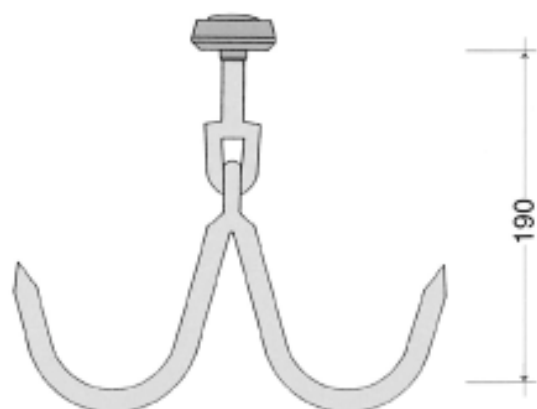

Artigo Nr. 464
Gancho Duplo Articulado

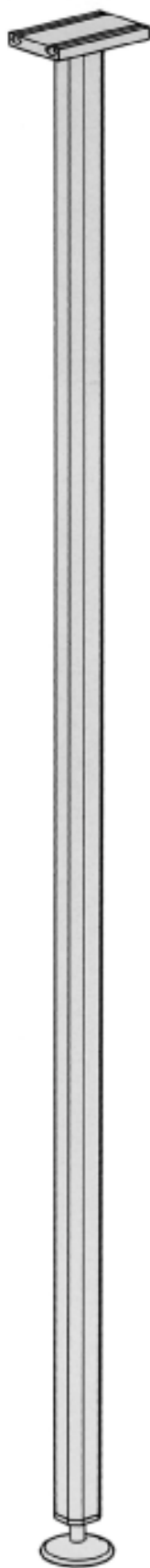

Nr. 700

Pilar em Perfil de Alumínio Tubular

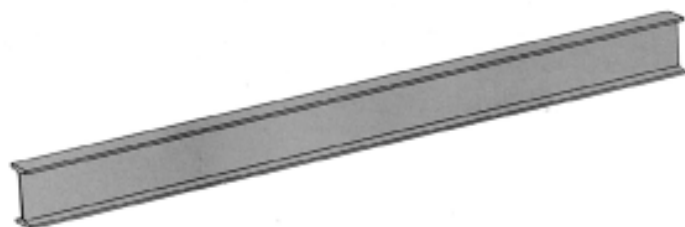

Nr. 711

Viga Metalizada IPN100

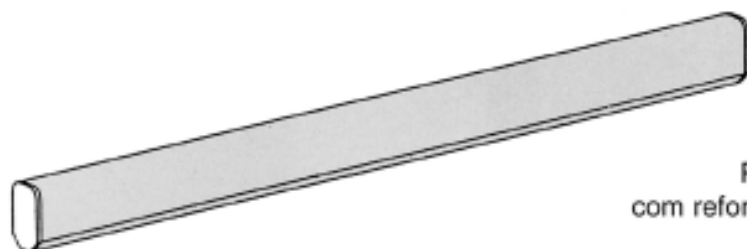

Nr. 710

Perfil de Alumínio Oval
com reforço em barra de 50x10



Nr. 712

Suporte de Perfil Oval

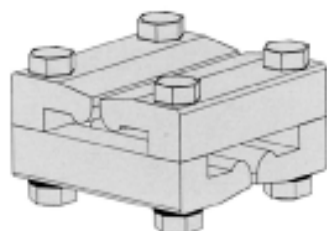

Nr. 417

Garra de Aperto da Viga IPN/IPN



Nr. 717

Garra de Aperto da Viga IPN ao Pilar



Nr. 507

Gancho Inox Ø 12mm