



Equipamentos Industriais, Lda.
Equipamentos Industriais, Lda.

Accessórios para Alimentações Eléctricas



FESEL (F. Sequeira), Lda.

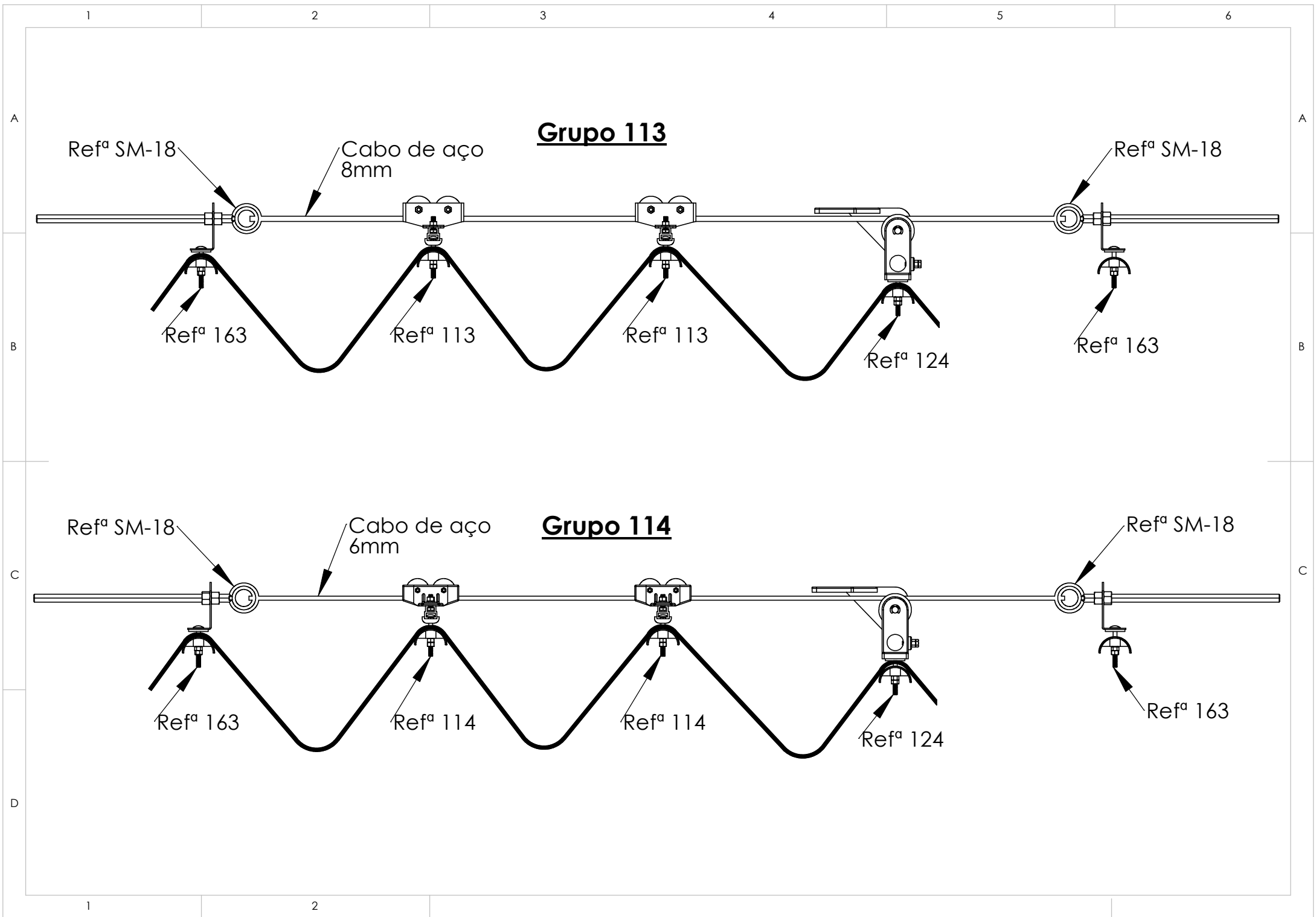

Cabo de aço

Cabo de aço de 6 ou 8mm

Refª 105

Carro simples porta abraçadeira

Refª 106

Carro duplo porta abraçadeira

Refª 163

Fixador

Refª 113

Carro porta cabos intermédio

Refª 114

Carro porta cabos intermédio

Refª 124

Carro porta cabos guia

A

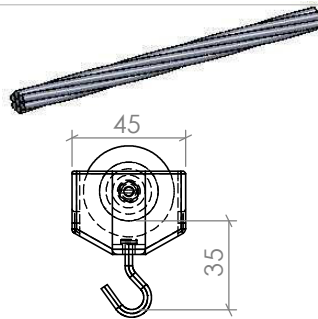
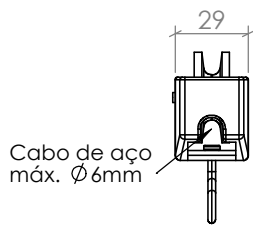

B

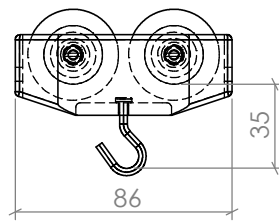
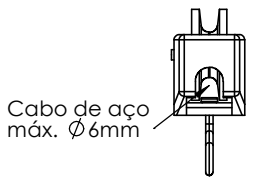

C

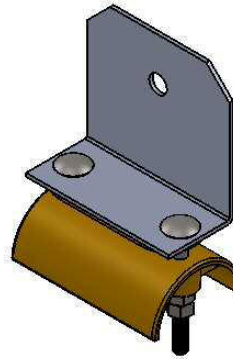
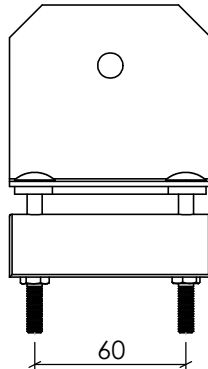
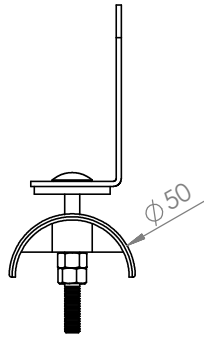

D

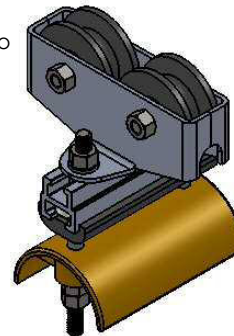
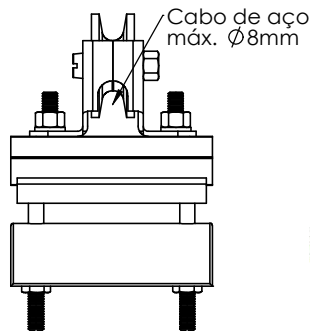
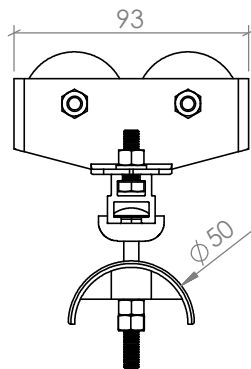

E

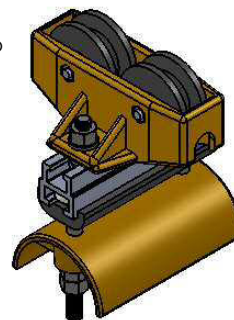
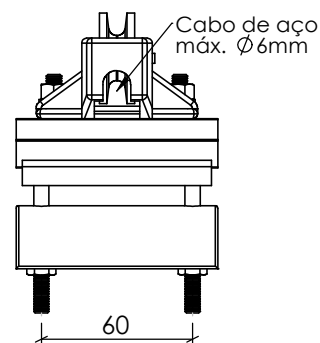
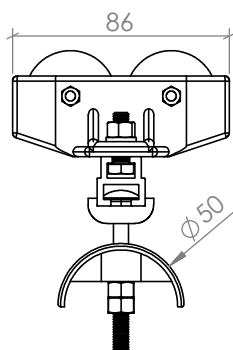

F

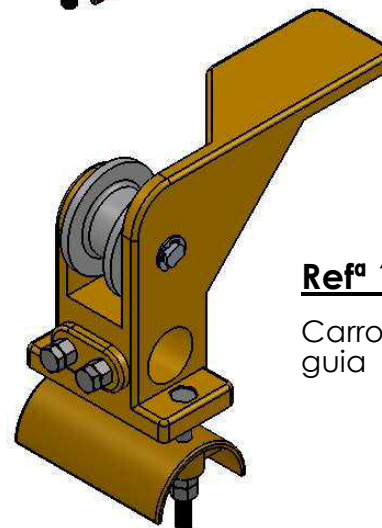
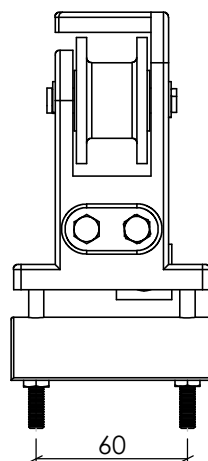
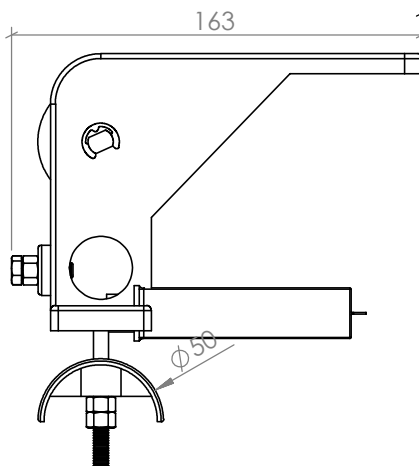

Cabo de aço

Cabo de aço de 6 ou 8mm

Refª 105/140 ou 141

Carro simples porta abraçadeira

Refª 106/140 ou 141

Carro duplo porta abraçadeira

Refª 163/130 ou 131

Fixador

Refª 113/130 ou 131Carro porta abraçadeira
cabo redondo
guia**Refª 114/130 ou 131**Carro porta abraçadeira
cabo redondo
guia**Refª 124/130 ou 131**Carro porta abraçadeira
cabo redondo

A

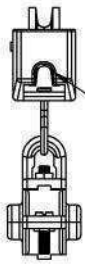
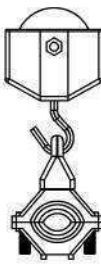
Cabo de aço
máx. \varnothing 6mm

B

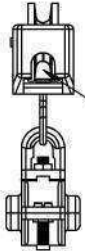
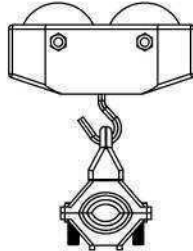
Cabo de aço
máx. \varnothing 6mm

C

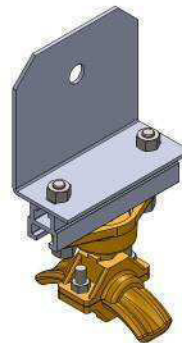
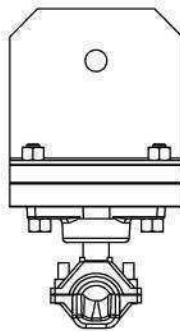
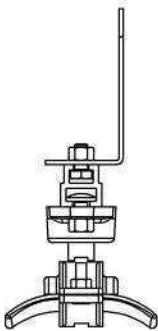

D

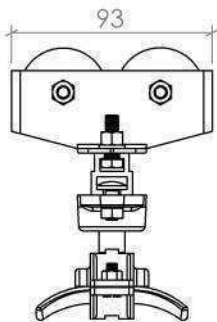

93

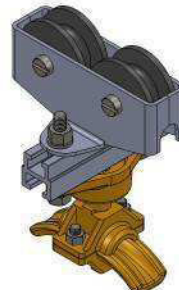
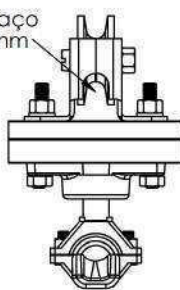
Cabo de aço
máx. \varnothing 6mm

E

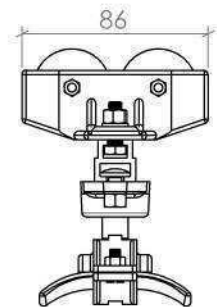

86

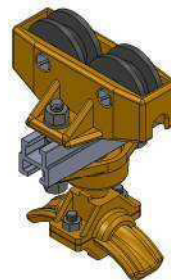
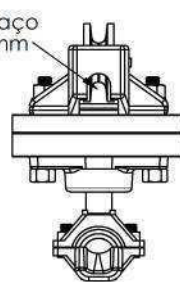
Cabo de aço
máx. \varnothing 6mm

F

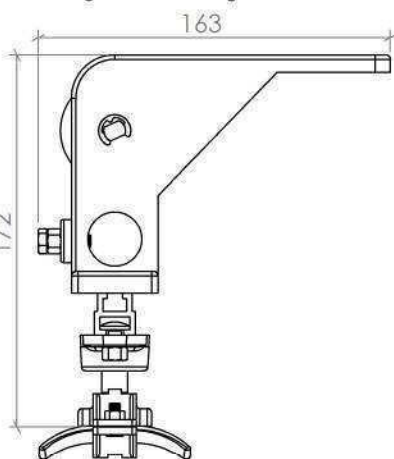

163

172

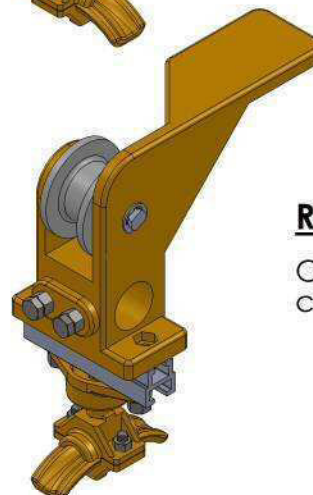
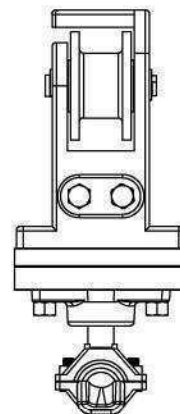

1 2 3 4 5 6

Grupo 215

Perfil metálico IPE

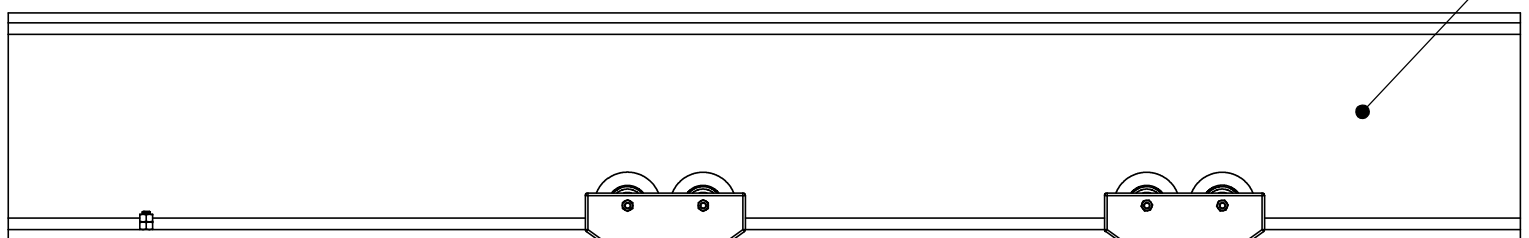

Refª 203

Refª 215

Refª 215

IPE 120 a 180: Refª 215-1
IPE 200 a 300: Refª 215-2
IPE 330 a 450: Refª 215-3

Abraçadeira
Refª 130 ou 131

Abraçadeira
Refª 130 ou 131

Abraçadeira
Refª 130 ou 131

Cabo redondo
ou mangueira
de $\varnothing 8$ a $\varnothing 27$ mm

Grupo 216

Perfil metálico IPE

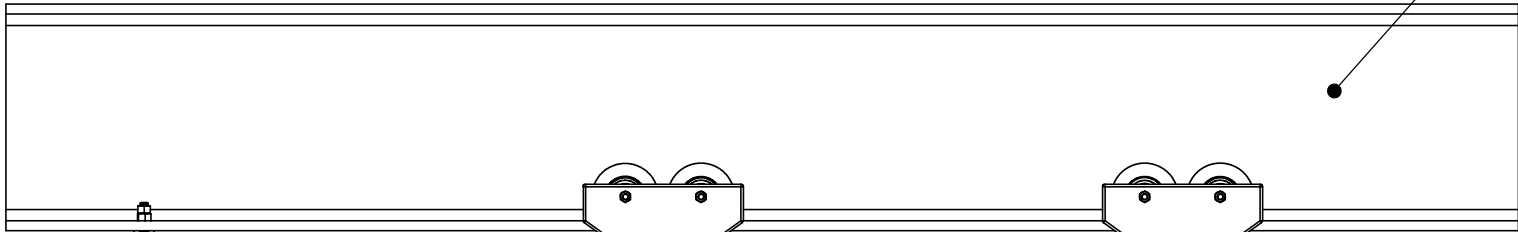

Refª 202

Refª 216

Refª 216

IPE 120 a 180: Refª 216-1
IPE 200 a 300: Refª 216-2
IPE 330 a 450: Refª 216-3

Cabo fita

1 2 3 4 5 6

A

A

B

B

C

C

D

D

IPE 120 a 180: Refª 215-1
 IPE 200 a 300: Refª 215-2
 IPE 330 a 450: Refª 215-3

IPE 120 a 180: Refª 216-1
 IPE 200 a 300: Refª 216-2
 IPE 330 a 450: Refª 216-3



A

B

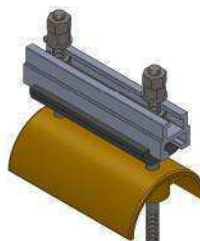
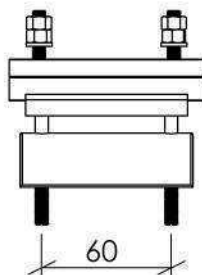
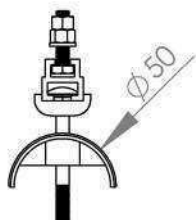

Refª 202

Fixador para cabo fita

C

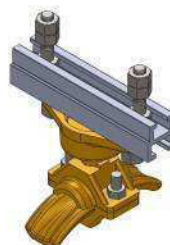
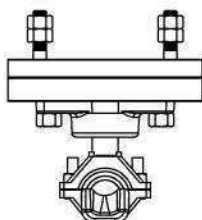
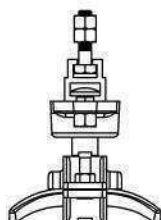

Refª 203/130 ou 131

Fixador para viga I com abraçadeira refª 130 ou 131

D

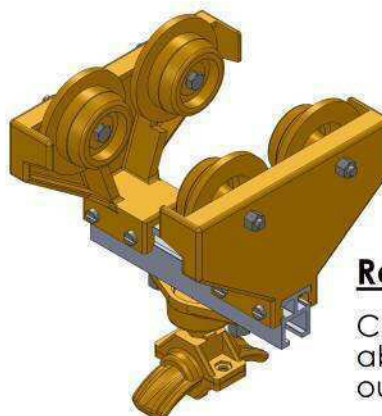
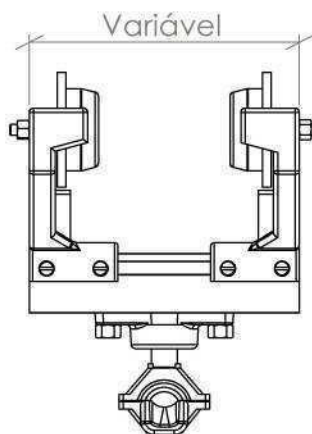
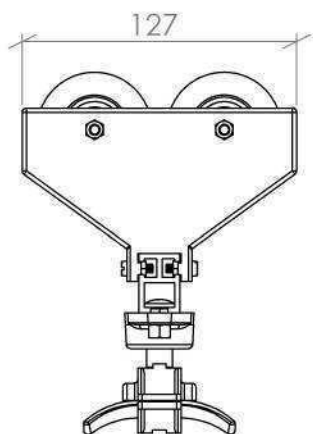

Refª 215/130 ou 131

Carro para viga I com abraçadeira refª 130 ou 131

E

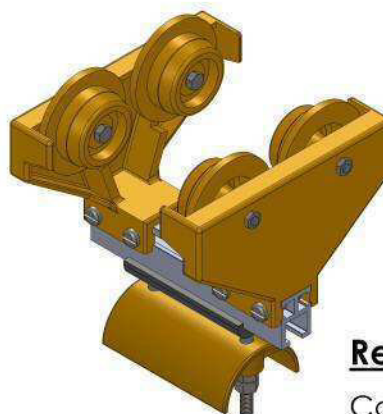
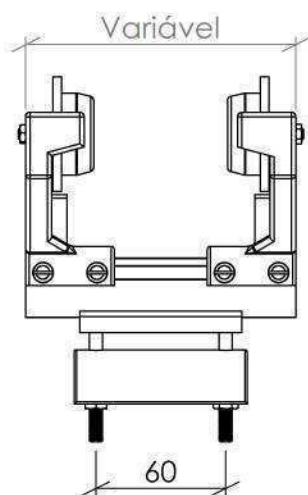
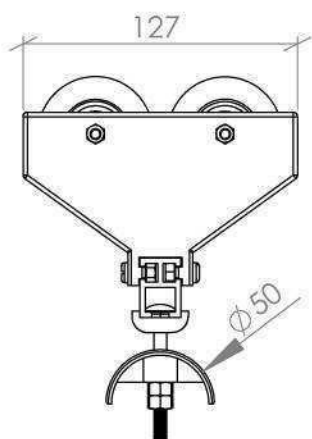

Refª 216

Carro para viga I com tambor

F

1 2 3 4 5 6

A

A

Grupo 230

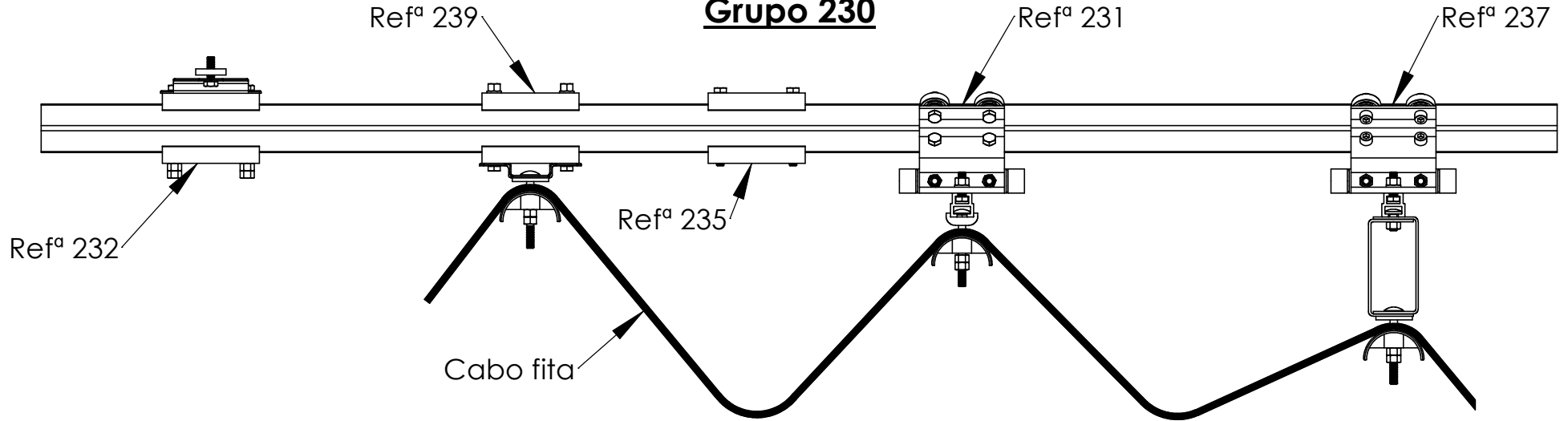

B

B

Grupo 230-130

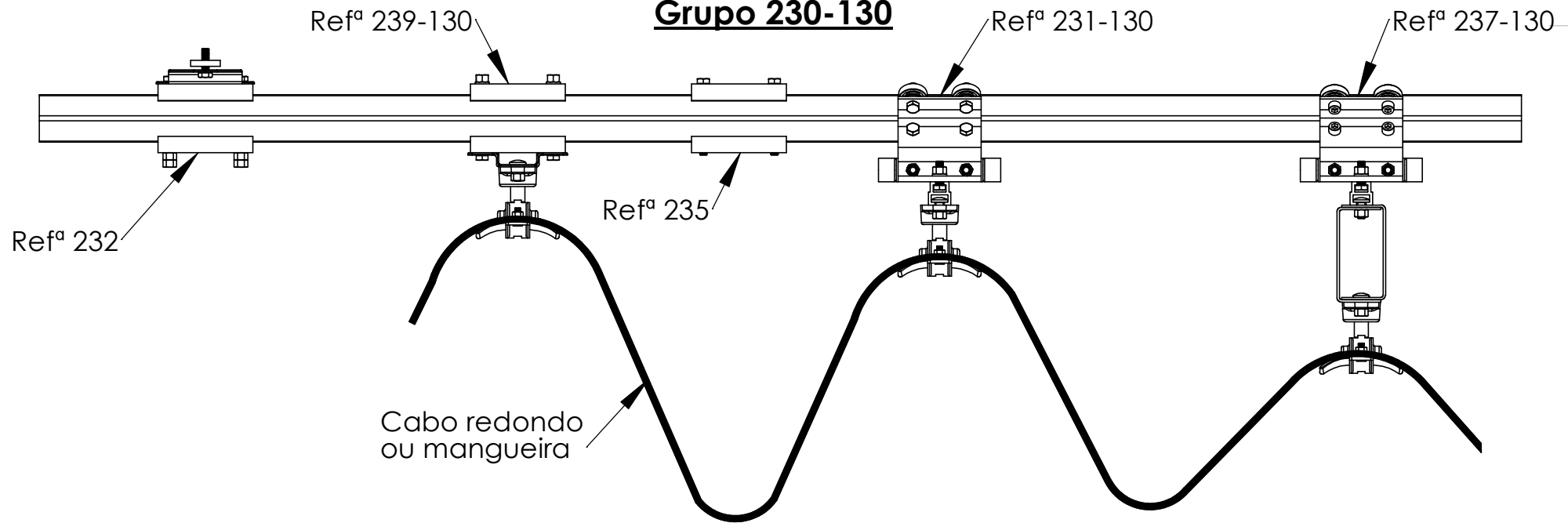

C

C

D

1 2 3 4 5 6

Tubo quadrado 30x30x2

A

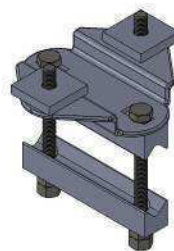
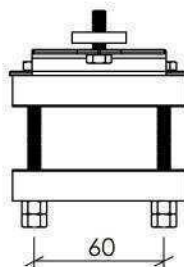
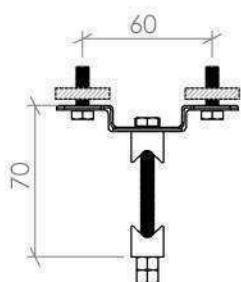
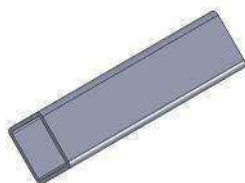
**Refª 232**

Suporte para tubo quadrado de 30mm

B

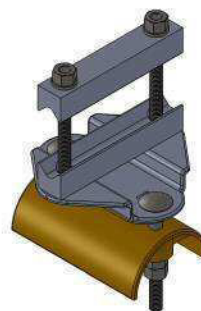
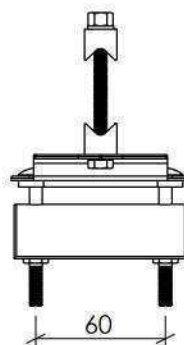
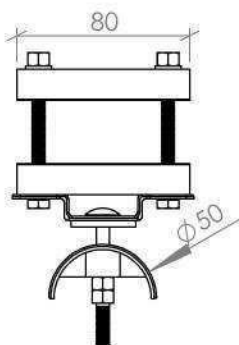
**Refª 239**

Fixador de cabo fita para tubo quadrado

C

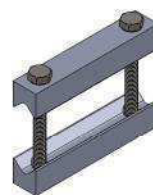
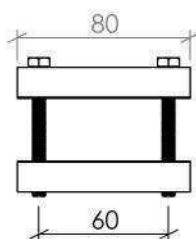
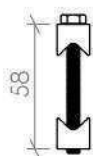
**Refª 235**

Junção para tubo quadrado de 30mm

D

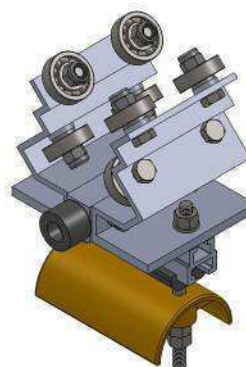
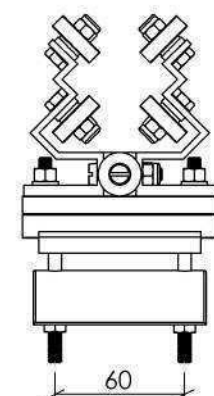
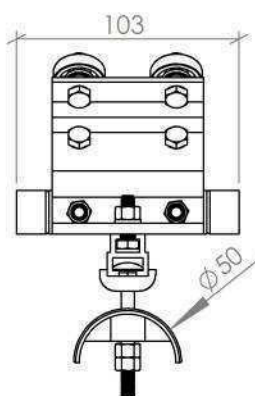
**Refª 231**

Carro p/ cabos intermédios p/ tubo quadrado de 30mm

E

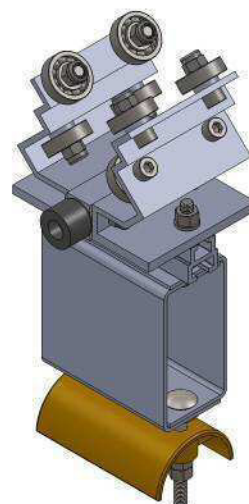
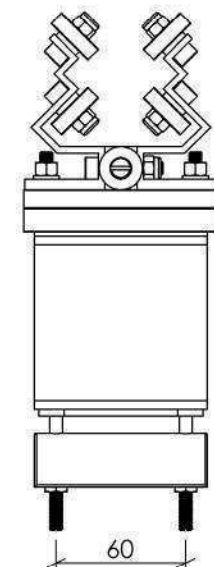
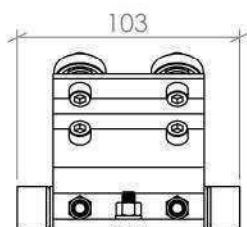
**Refª 237**

Carro p/ cabos guia p/ tubo quadrado de 30mm

F

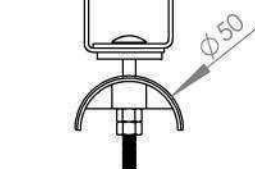

Tube quadrado 30x30x2

A

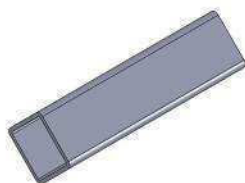
**Refª 232**

Suporte para tubo quadrado de 30mm

B

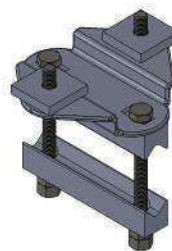
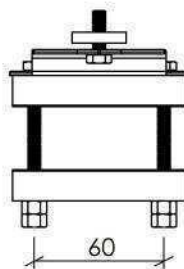
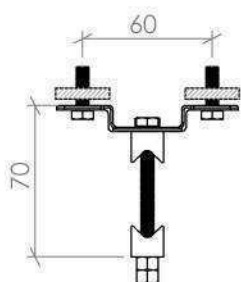
**Refª 239/130 ou 131**

Fixador de cabo redondo ou mangueira para tubo quadrado

C

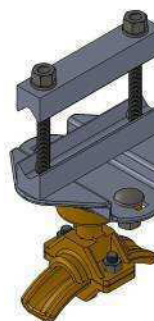
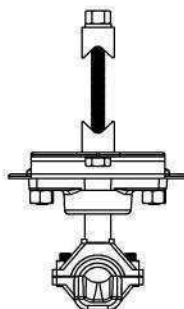
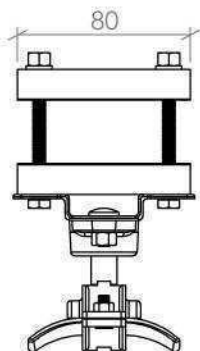
**Refª 235**

Junção para tubo quadrado de 30mm

D

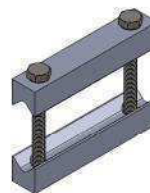
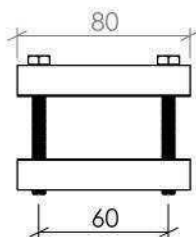
**Refª 231/130 ou 131**

Carro p/ cabos intermédios p/ tubo quadrado de 30mm

E

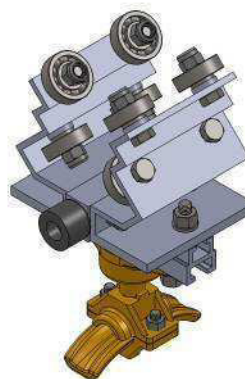
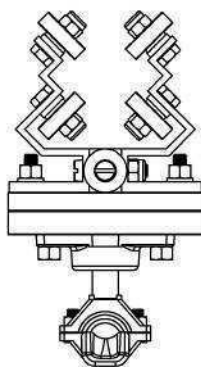
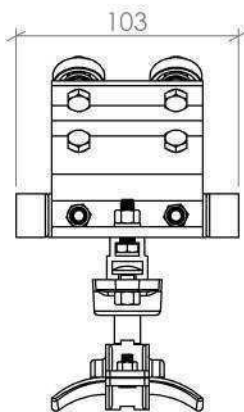
**Refª 237/130 ou 131**

Carro p/ cabos guia p/ tubo quadrado de 30mm

F

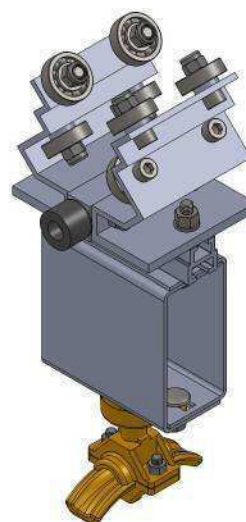
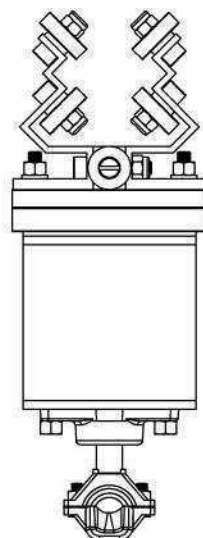
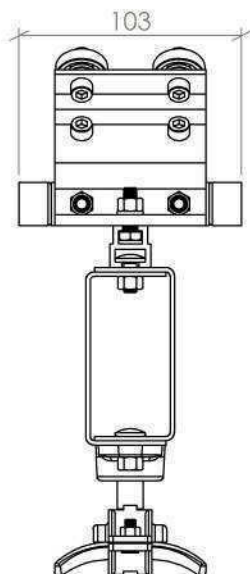

A

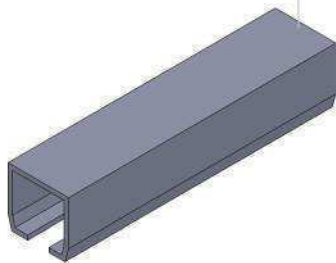
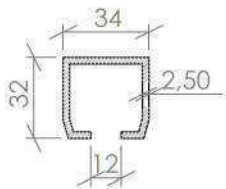

Refª 205 / AL

Calha de alumínio em comprimentos de 4 metros

B

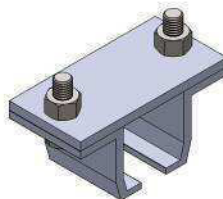
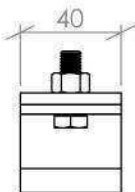
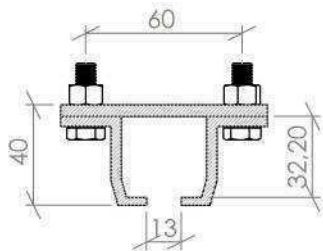

Refª 226

Suportes de calha afastados no máximo 1,50 metros

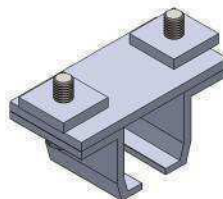
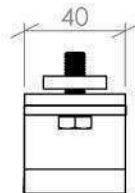
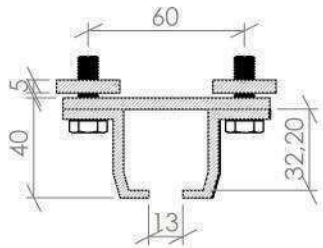

Refª 226 / C

Suportes de calha afastados no máximo 1,50 metros

C

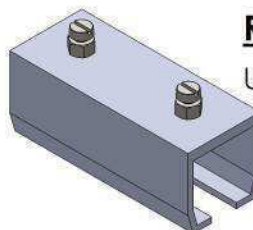
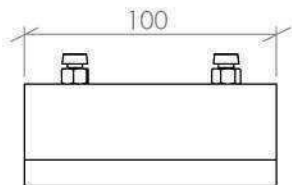
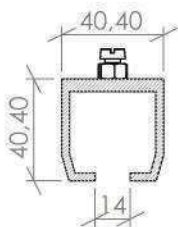

Refª 305

União de calha alumínio

D

E

F

A

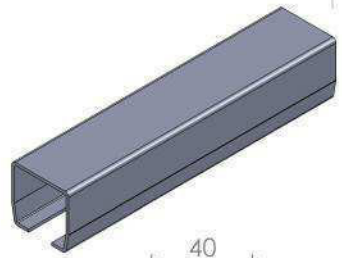
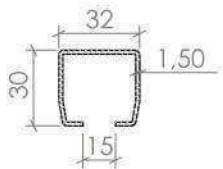

Refª 205 / ZN

Calha galvanizada em comprimentos de 4 metros

B

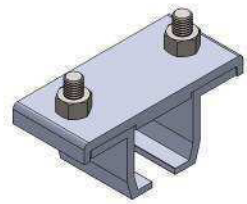
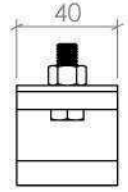
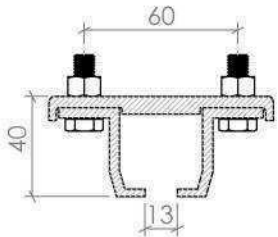

Refª 224

Suportes de calha afastados no máximo 1,50 metros

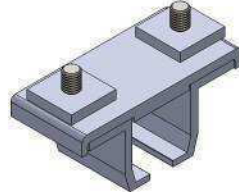
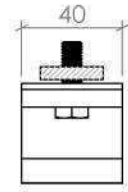
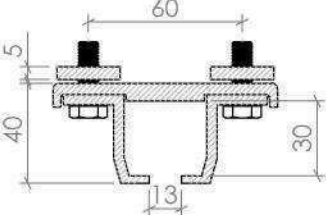

Refª 224 / C

Suportes de calha afastados no máximo 1,50 metros

C

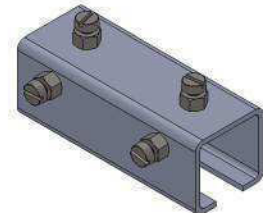
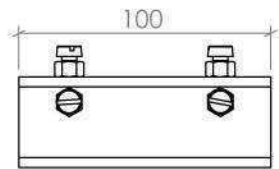
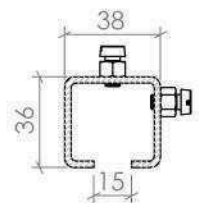

Refª 211

União de calha zincada

D

E

F

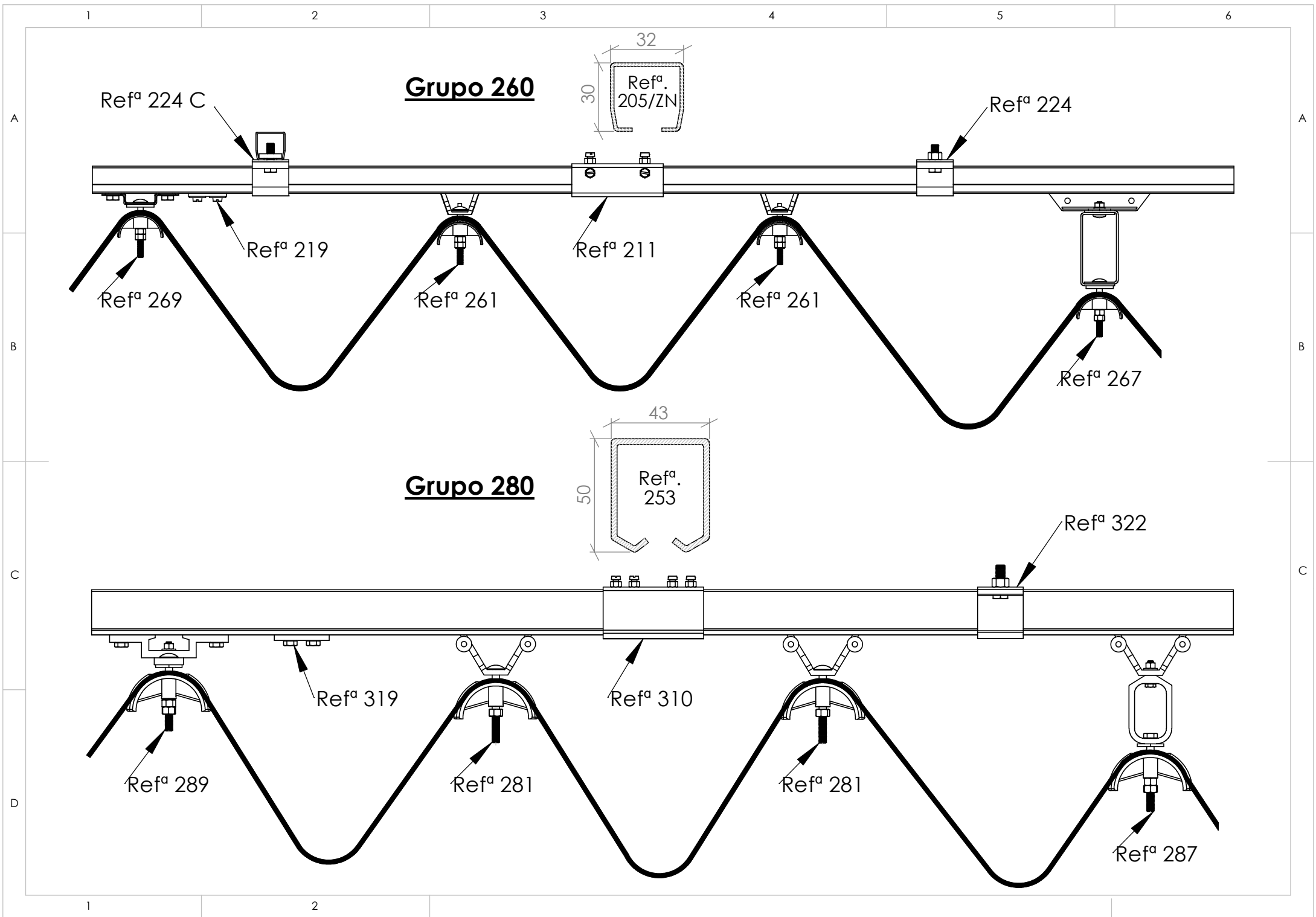

A

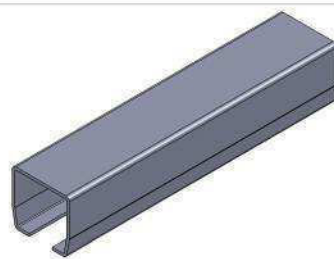
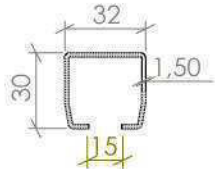

Refª 205 / ZN

Calha galvanizada em comprimentos de 4 metros

B

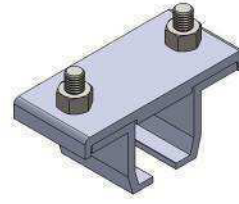
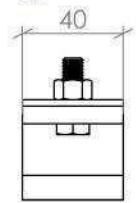
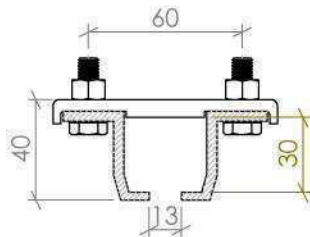

Refª 224

Suportes de calha afastados no máximo 1,50 metros

C

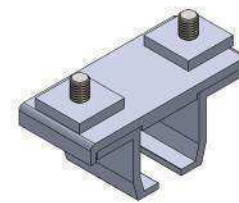
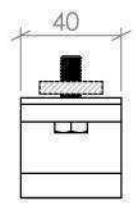
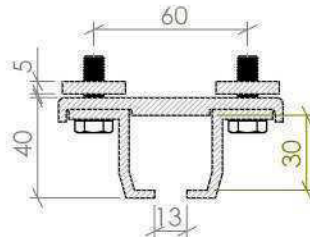

Refª 224 / C

Suportes de calha afastados no máximo 1,50 metros

D

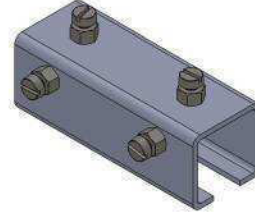
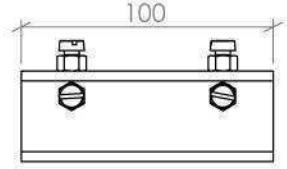
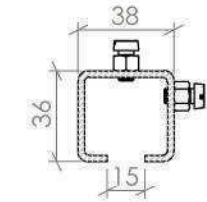

Refª 211

União de calha zincada

E

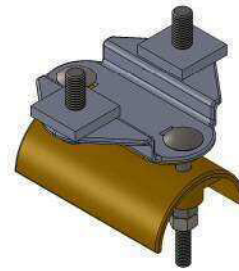
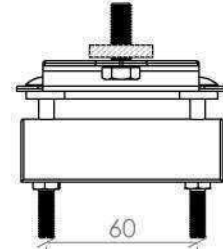
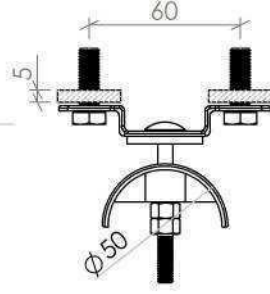

Refª 269

Fixador de cabo de fita

F

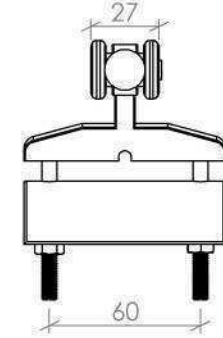
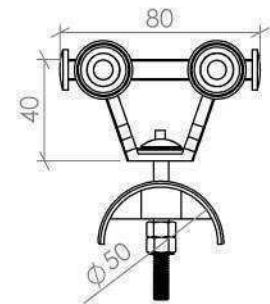

Refª 261

Carro porta cabos-fita intermédio

F

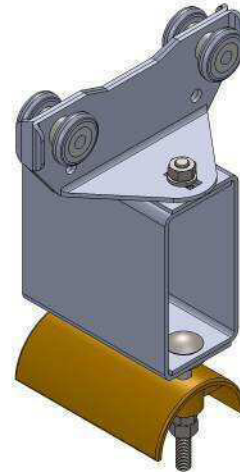
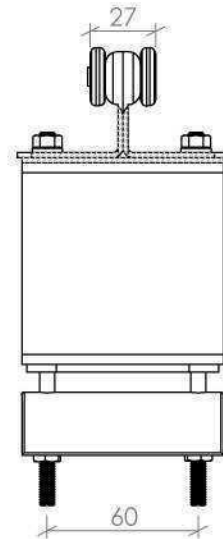
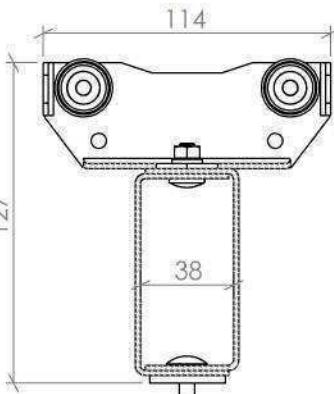

Refª 267

Carro porta cabos-fita guia

A

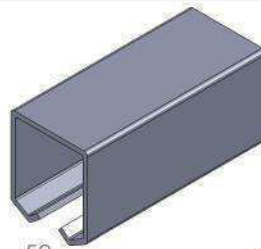
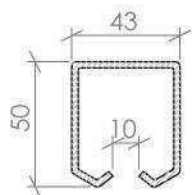
**Refª 253**

Calha de aço em
comprimentos de 6 metros

B

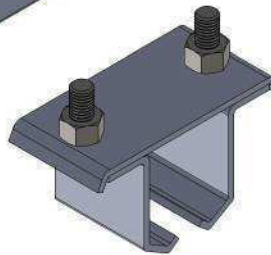
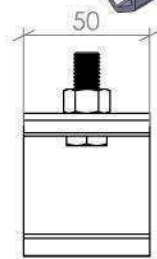
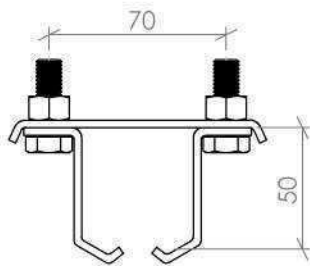
**Refª 322**

Suportes de calha afastados
no máximo 2,00 metros

C

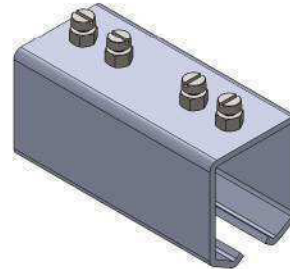
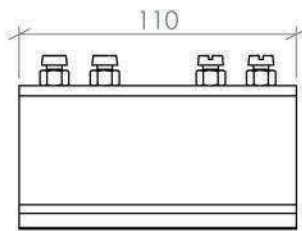
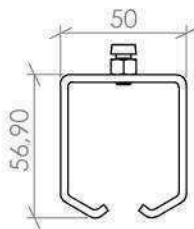
**Refª 310**

União de calha em aço

D

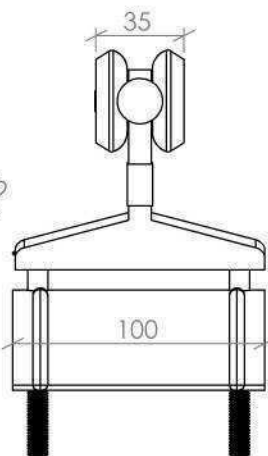
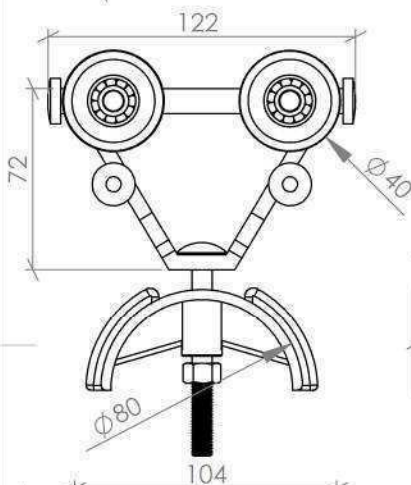
**Refª 281**

Carro porta cabos-fita
intermédio

E

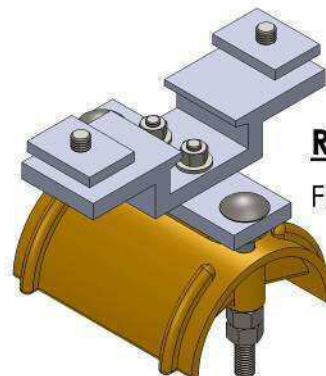
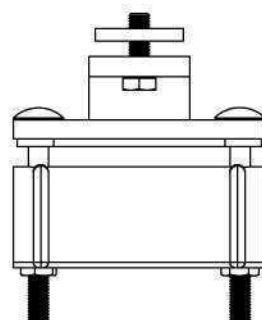
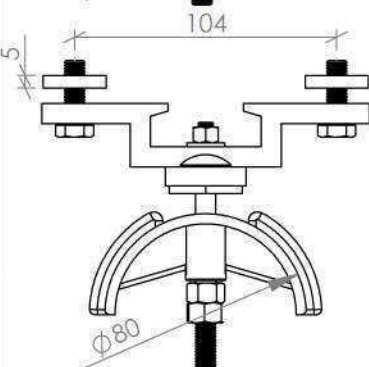
**Refª 289**

Fixador de cabo de fita

F

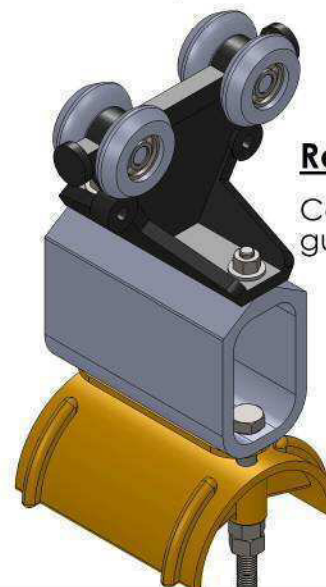
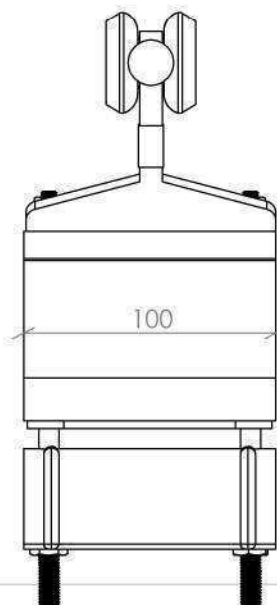
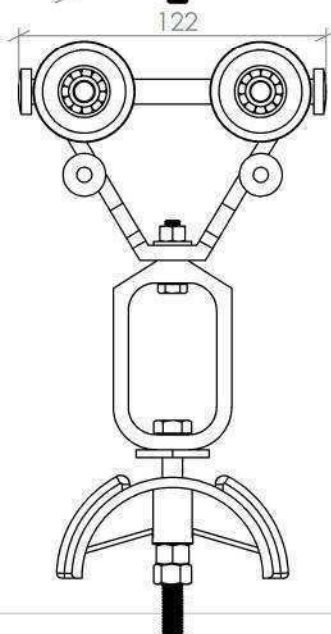
**Refª 287**

Carro porta cabos-fita
guia

1 2 3 4 5 6

A

A

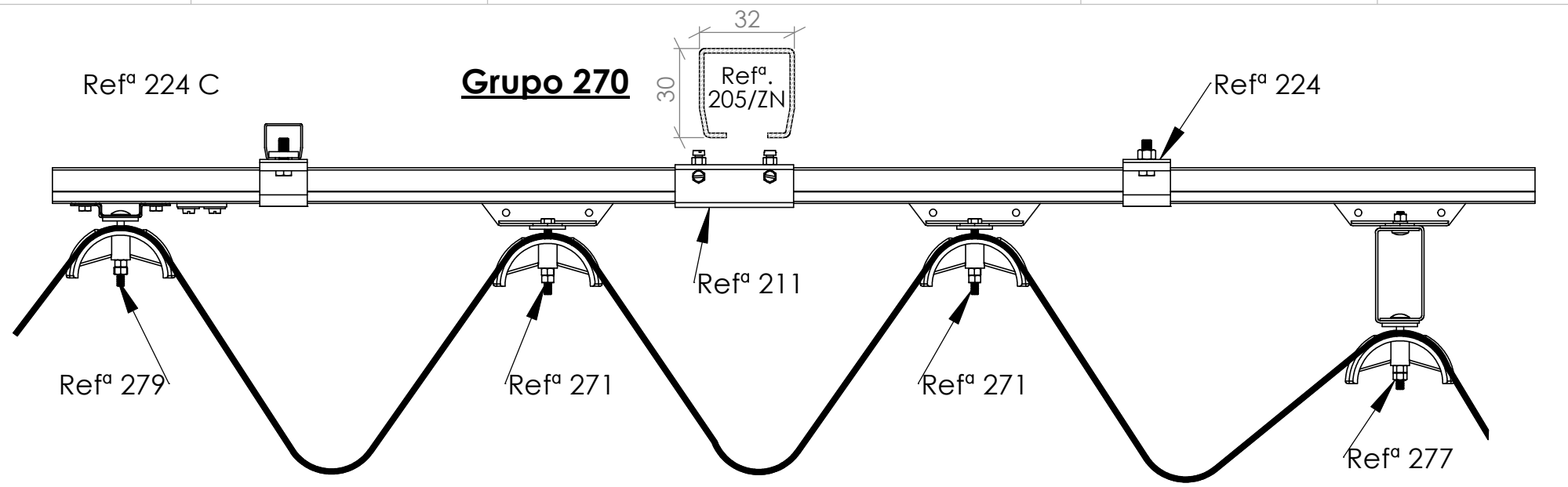

B

B

C

C

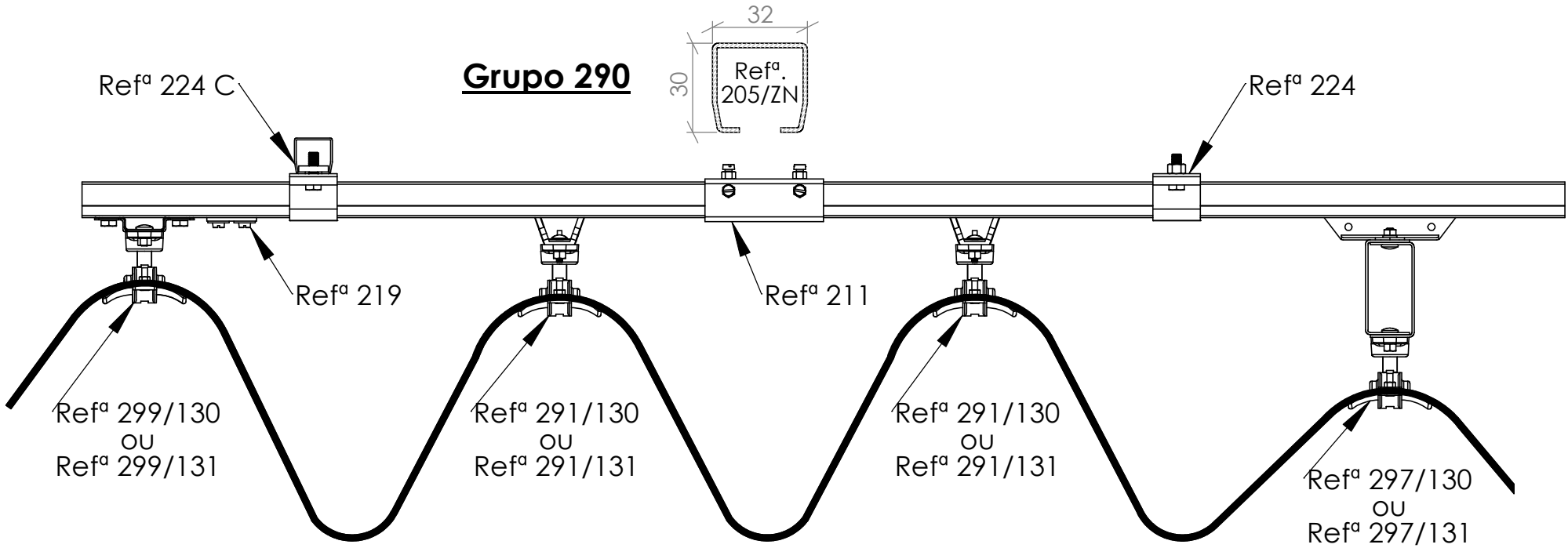

D

Abraçadeiras Refª 130 - Cabos ou mangueiras ϕ 8 a ϕ 16mm
Abraçadeiras Refª 131 - Cabos ou mangueiras ϕ 17 a ϕ 27mm

1 2 3 4 5 6

A

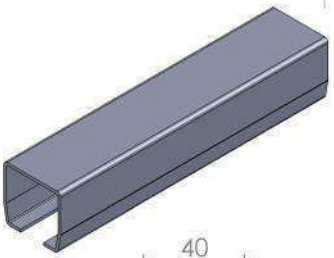
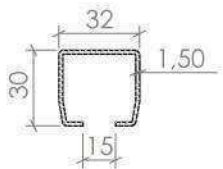

Refª 205 / ZN

Calha galvanizada em comprimentos de 4 metros

B

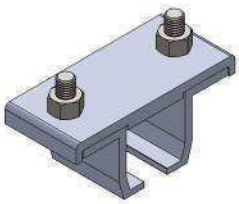
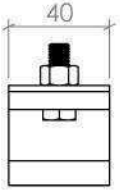
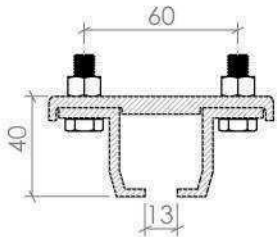

Refª 224

Suportes de calha afastados no máximo 1,50 metros

C

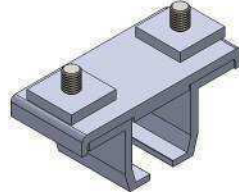
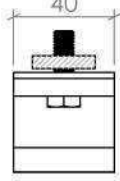
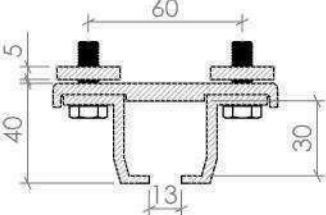

Refª 224 / C

Suportes de calha afastados no máximo 1,50 metros

D

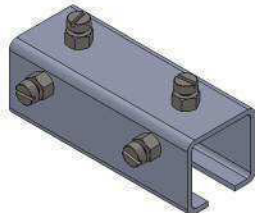
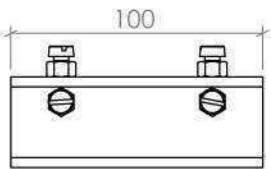
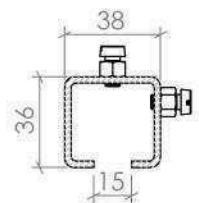

Refª 211

União de calha zincada

E

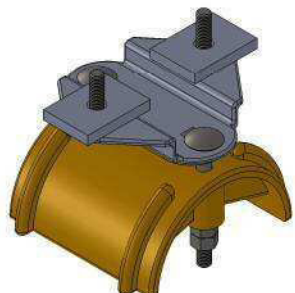
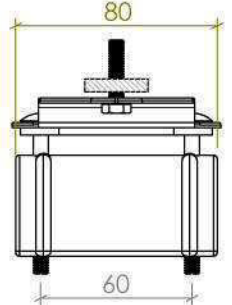
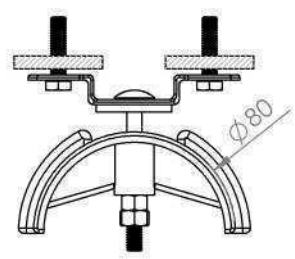

Refª 279

Fixador de cabo de fita

F

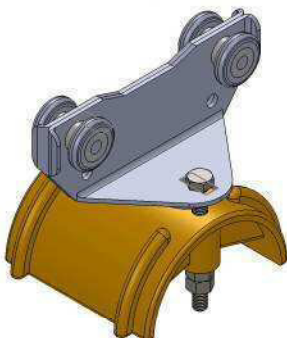
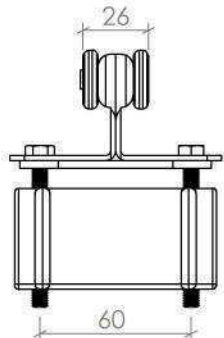
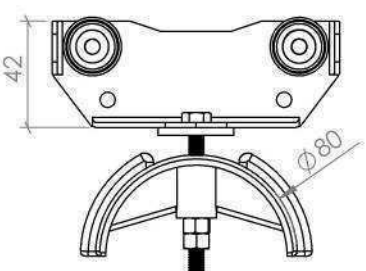

Refª 271

Carro porta cabos-fita intermédio

F

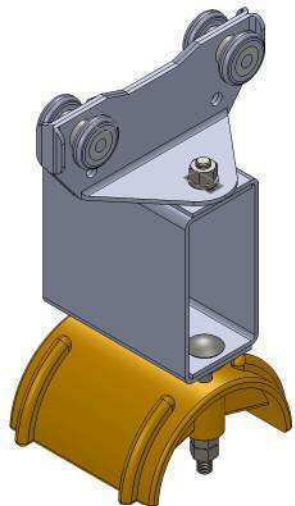
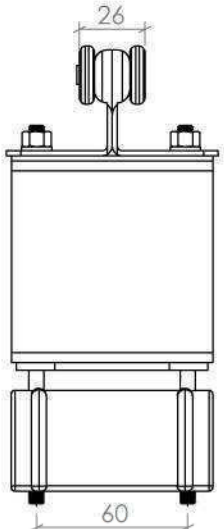
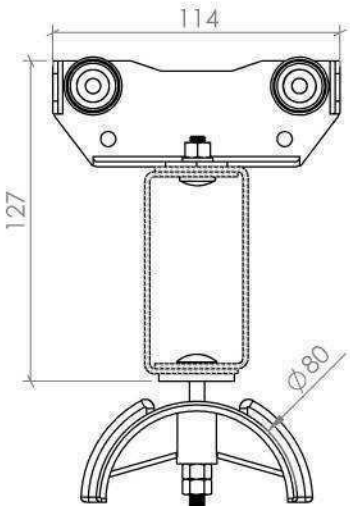

Refª 277

Carro porta cabos-fita guia

A

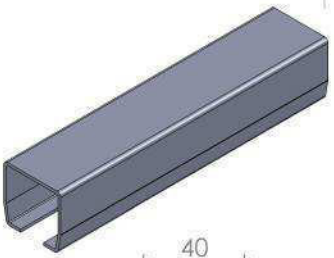
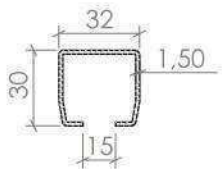

Refª 205 / ZN

Calha galvanizada em comprimentos de 4 metros

B

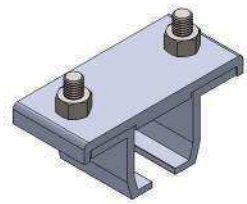
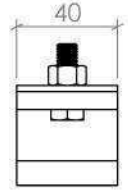
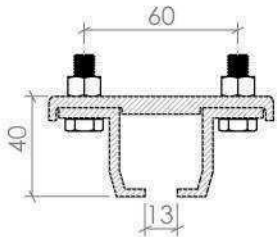

Refª 224

Suportes de calha afastados no máximo 1,50 metros

C

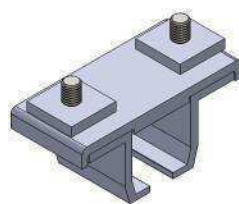
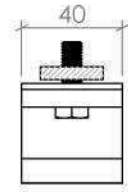
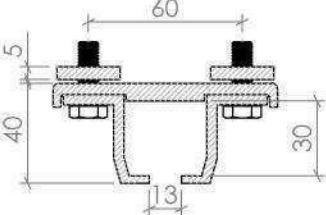

Refª 224 / C

Suportes de calha afastados no máximo 1,50 metros

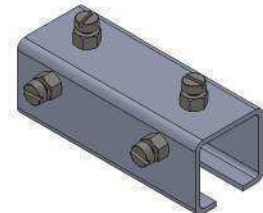
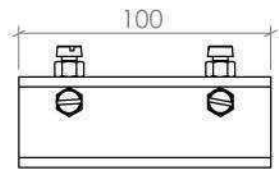
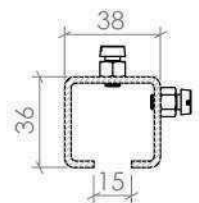

Refª 211

União de calha zincada

D

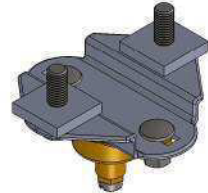
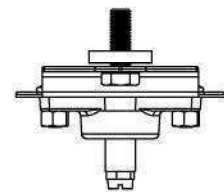
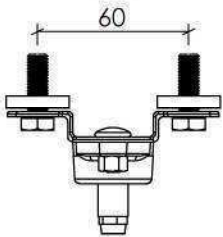

Refª 299

Fixador de abraçadeira cabo de redondo

E

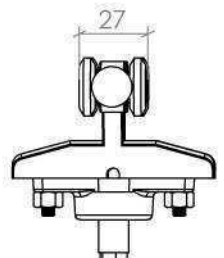
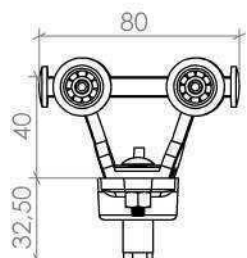

Refª 291

Carro porta abraçadeira cabo redondo

F

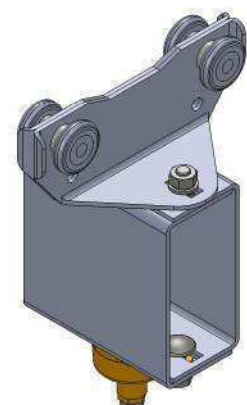
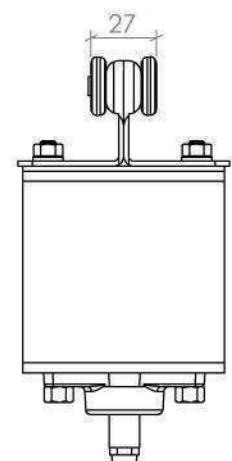
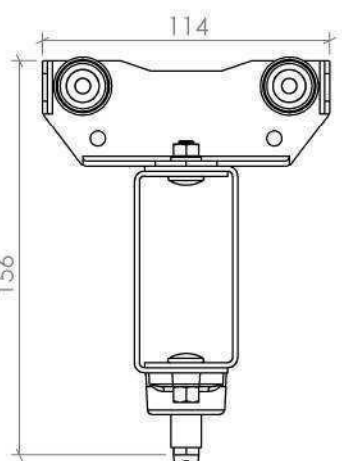

Refª 297

Carro porta abraçadeira cabo redondo guia

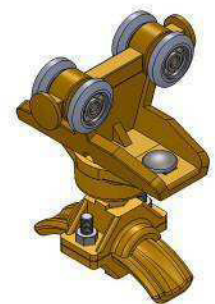

Refª 130

Abraçadeira Ø8 a 16mm

Refª 131

Abraçadeira Ø17 a 27mm

Refª 291/131/130